WALL SPEAKER



Wall Speaker

FS-30N/52N/60N/100N

FS Series is designed for high quality, professional sound reproduction which is ideal for BGM playback and paging. With the high quality transformer can minimize losses during long distance transfer
Using the mounting bracket with safety hook can be installed to the correct speaker orientation.



FEATURES

- Full-range (30N, 60N, 100N) or 2Way (52N) speaker system
- Use for high impedance and low impedance (Slide Switch)
- Screw terminals for easy installation
- High quality transformer for long-distance installation
- Optimized port design by high-strength ABS injection enclosure
- High-density sound-absorbing material for the removal of internal resonance
- The high-strength powder coated Grille and sound
- Black/White Version
- Safety hook considering the user's safety
- High strength articulated wall-mounting bracket (Optional Bracket, FSB-3)
- Horizontal and vertical adjustments and mechanism design for a rigid fixing

SPECIFICATION

Model		FS-30N	FS-52N	FS-60N	FS-100N
Type		5.25" Full-range Wall Mount Speaker	5.25" 2Way Wall Mount Speaker	5.25" Full-range Wall Mount Speaker	Dual 5.25" Full-range Wall Mount Speaker
Driver		5"	5" WF, 1" Dome TW	5"	5"
Power Handling (AES)		30W	50W	60W	100W
Input Power	100V	30W	50W	60W	100W
	70V	-	-	-	-
Impedance	100V	330Ω	200Ω	167Ω	100Ω
	70V	-	-	-	-
	LOW	8Ω	8Ω	8Ω	8Ω
Power Selection		Slide Switch	Slide Switch	Slide Switch	Slide Switch
Frequency Response(-10dB)		93Hz ~ 16kHz	76Hz ~ 20kHz	97Hz ~ 16.5kHz	-
Frequency Range(-20%)		60Hz ~ 20kHz	65Hz ~ 20kHz	69Hz ~ 19.2kHz	100Hz ~ 12kHz
Sensitivity (1W/1m, 1kHz) ^{†1}		90dB	86dB	90dB	90dB
Maximum SPL[Cont] ^{†1}		105dB	103dB	108dB	110dB
Nominal Dispersion(HxV)	1kHz	195° x 101°	187° x 144°	199° x 101°	199° x 101°
	4kHz	97° x 29°	80° x 34°	109° x 32°	109° x 32°
Input Connector		2P Screw Terminal	2P Screw Terminal	2P Screw Terminal	2P Screw Terminal
Enclosure Material		ABS GF 20% (V0)	ABS GF 20% (V0)	ABS GF 20% (V0)	ABS GF 20% (V0)
Enclosure Color		Black/White	Black/White	Black/White	Black/White
Grille Material		Metal Grille	Metal Grille	Metal Grille	Metal Grille
Grille Color		Black/White	Black/White	Black/White	Black/White
Weights (Net)		2.77kg	3.23kg	3kg	3.8kg
Dimensions (Net, WxHxD, mm)		177 x 302 x 163	177 x 302 x 163	177 x 302 x 163	177 x 302 x 163
Weather Resistant		-	-	-	-
Flame Resistant		-	-	-	-
Certification		-	-	-	-
Included Accessories		Knuckle Bracket, Safety Wire	Knuckle Bracket, Safety Wire	Knuckle Bracket, Safety Wire	Knuckle Bracket, Safety Wire

^{†1} : At floor test

FS-30N/52N/60N/100N

Wall
Speaker

TECHNICAL DATA

DIMENSION

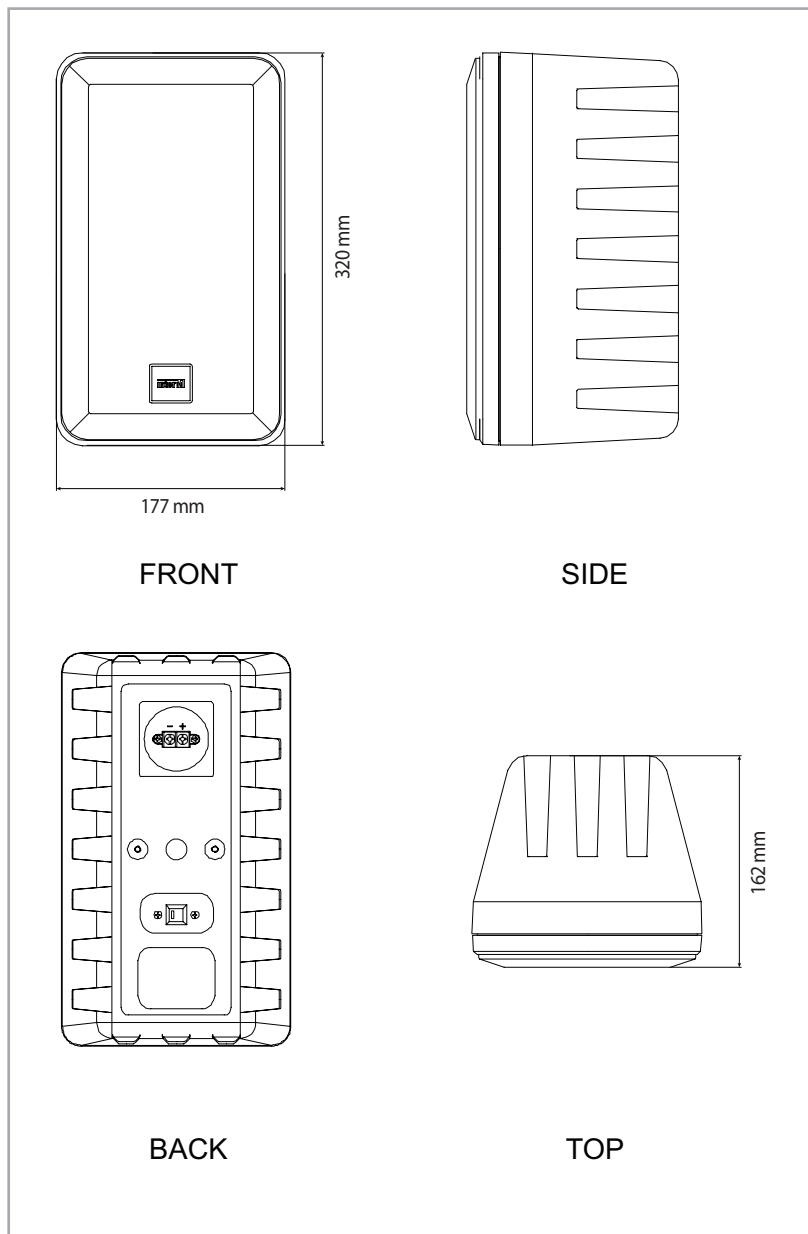

Wall Speaker

FS-30N/52N/60N/100N

TECHNICAL DATA

FREQUENCY RANGE

• FS-30N

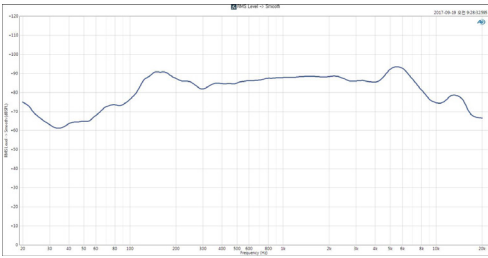

POLAR PATTERN (1kHz)

• FS-30N

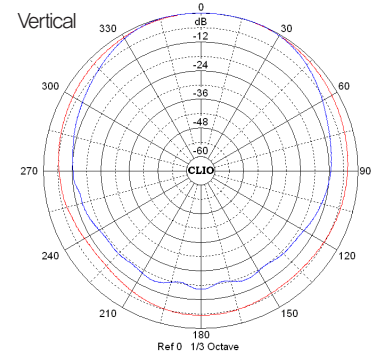
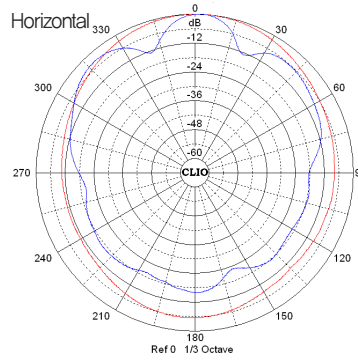

• FS-52N

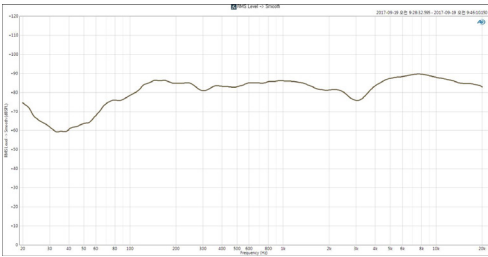

• FS-52N

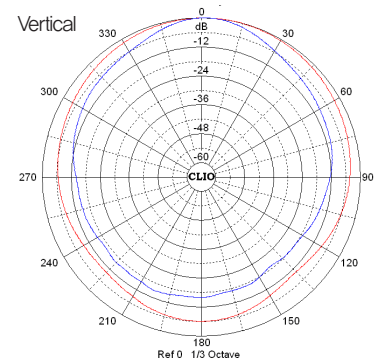
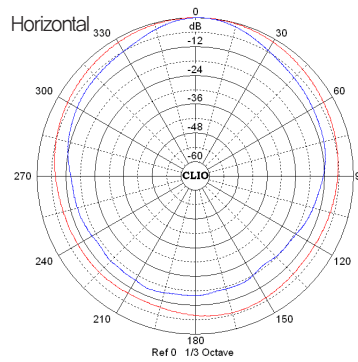

• FS-60N

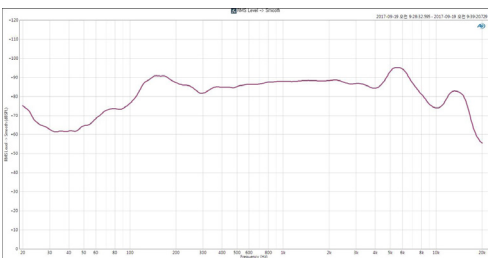

• FS-60N

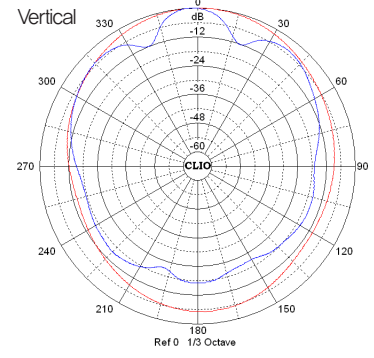
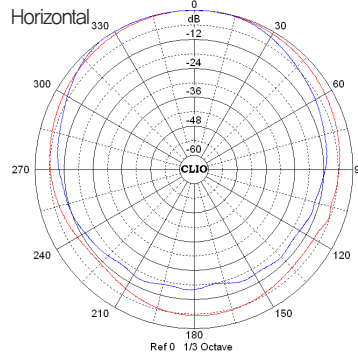

• FS-100N

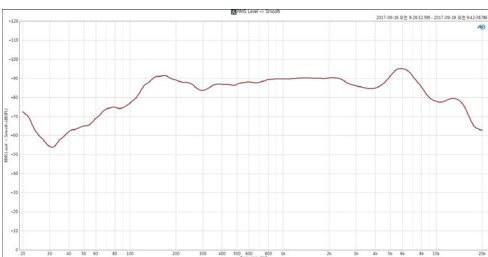

• FS-100N

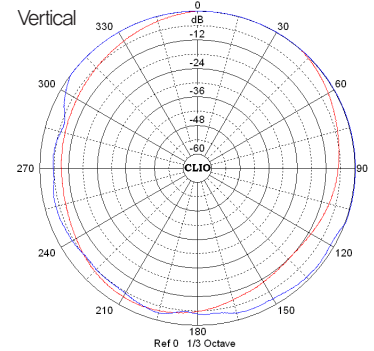
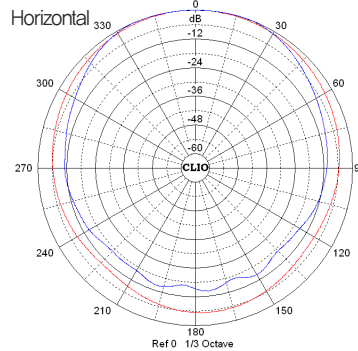

FS-30N/52N/60N/100N

Wall
Speaker

SPEAKER INSTALLATION GUIDE

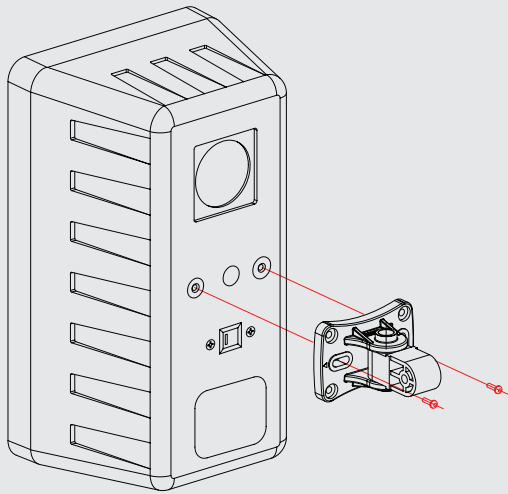

STEP 01

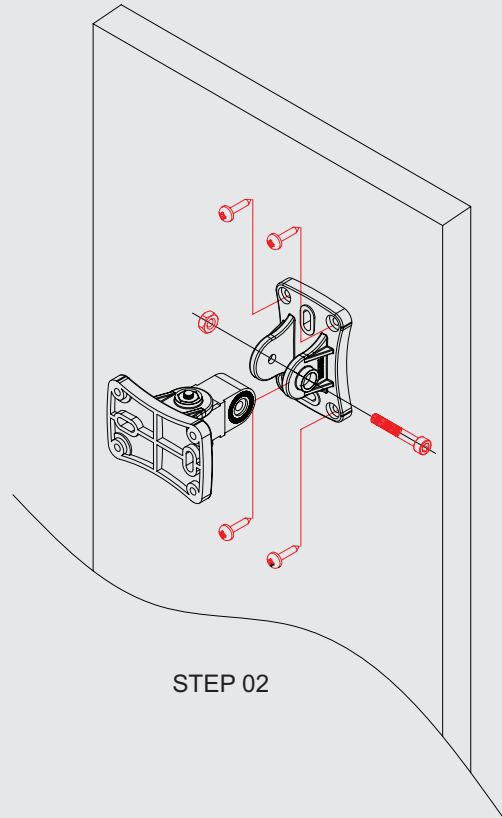

STEP 02

Wall Speaker

WS-15T/30T/50T/80T

WS Series is professional compact indoor/outdoor loudspeaker for background/foreground music. It can be used in various applications from small-sized venues to mid/large-sized venues. It can be installed with steel-made durable U bracket or rotatable Knuckle bracket by user's demand.



FEATURES

- **A Selection of Line-up**
- **70V/100V multi-tap transformer**
- **Compact size with high power**
Depending on the sizes, the series provides high output just with a small unit using 1Way Full-range (WS-15T) or 2Way Passive (WS-30T/50T/80T) speaker system.
- **Asymmetric horn for the optimized sound system.**
- **Weather resistant design**
- **Sound quality of professional audio**
- **Easy installation**

SPECIFICATION

Model	WS-15T	WS-30T	WS-50T	WS-80T
Type	2.5" Full-range Wall Mount Speaker	4" 2Way Passive Wall Mount Speaker	5" 2Way Passive Wall Mount Speaker	6.5" 2Way Passive Wall Mount Speaker
Driver	2.5"	WF : 4", TW : 13mm	WF : 5", TW : 13mm	WF : 6.5", TW : 13mm
Power Handling (AES)	15W	30W	50W	80W
Input Power	100V	15W	30/15W	50/25W
	70V	-	-	-
Impedance	100V	660Ω	330/660Ω	200/400Ω
	70V	-	-	-
	LOW	8Ω	8Ω	8Ω
Power Selection	By Terminal	By Terminal	By Terminal	By Terminal
Frequency Response(-10dB)	120Hz ~ 20kHz	108Hz ~ 20kHz	94Hz ~ 20kHz	80Hz ~ 20kHz
Frequency Range(-20%)	111Hz ~ 20kHz	83Hz ~ 20kHz	69Hz ~ 20kHz	60Hz ~ 20kHz
Sensitivity (1W/1m, 1kHz)	79dB	84dB	87dB	86dB
Maximum SPL[Cont]	90dB	95dB	104dB	105dB
Nominal Dispersion(HxV)	90°	Asymmetric Horn Horizontal Coverage : Far Field 60°, Near Field 120° Vertical Coverage : upward +20°, downward -40° (On Axis)		
Input Connector	3P Screw Terminal	4P Screw Terminal	4P Screw Terminal	4P Screw Terminal
Enclosure Material	ABS	ABS	ABS	ABS
Enclosure Color	Black/White	Black/White	Black/White	Black/White
Grille Material	Metal Grille	Metal Grille	Metal Grille	Metal Grille
Grille Color	Black/White	Black/White	Black/White	Black/White
Weights (Net)	0.89kg	1.68kg	2.34kg	3.58kg
Dimensions (Net, WxHxD, mm)	92 x 120 x 114	139 x 210 x 129	173 x 250 x 150	210 x 311 x 169
Weather Resistant	IP54	IP54	IP54	IP54
Flame Resistant	-	-	-	-
Certification	-	-	-	-
Included Accessories	Knuckle Bracket Safety Wire	Knuckle or U Bracket Safety Wire	Knuckle or U Bracket Safety Wire	Knuckle or U Bracket Safety Wire

WS-15T/30T/50T/80T

Wall
Speaker

TECHNICAL DATA

DIMENSION

• WS-15T

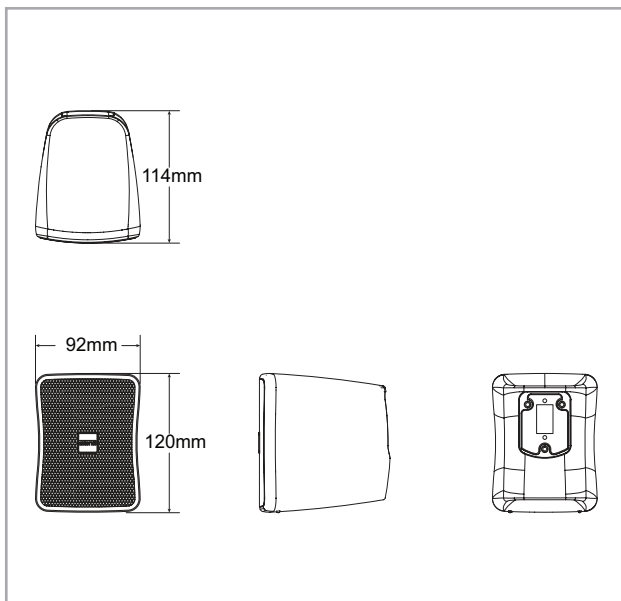

• WS-30T

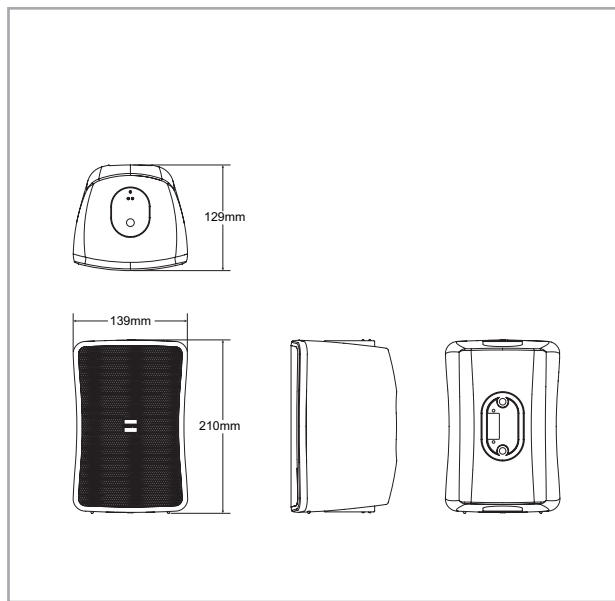

• WS-50T

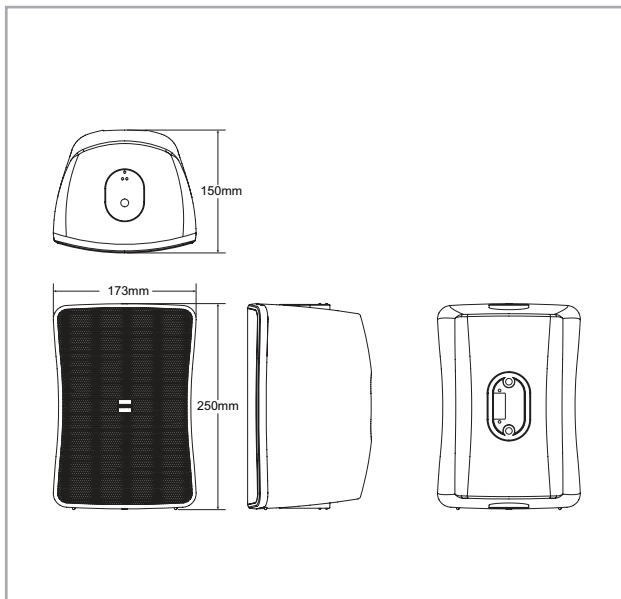

• WS-80T

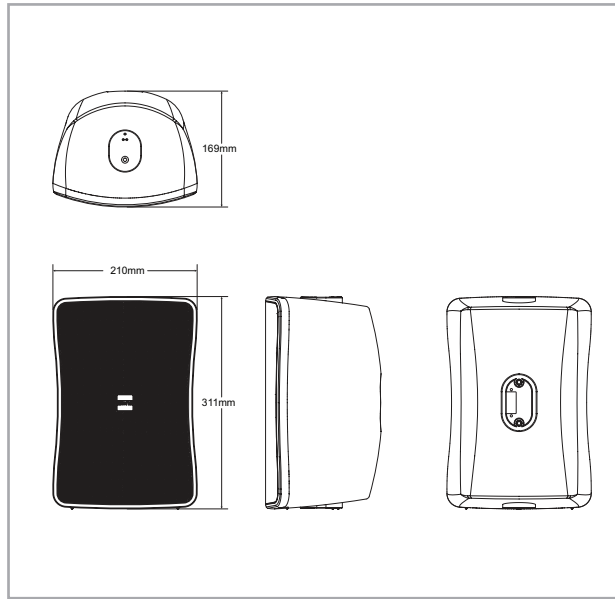

Wall Speaker

WS-15T/30T/50T/80T

TECHNICAL DATA

FREQUENCY RANGE

• WS-15T

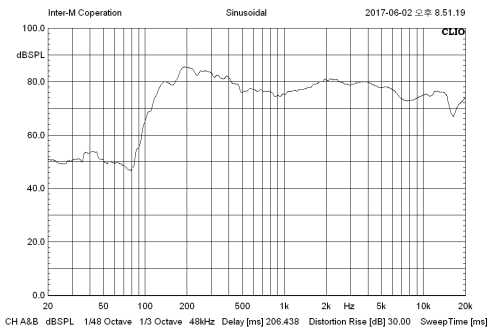

POLAR PATTERN (1kHz)

• WS-15T

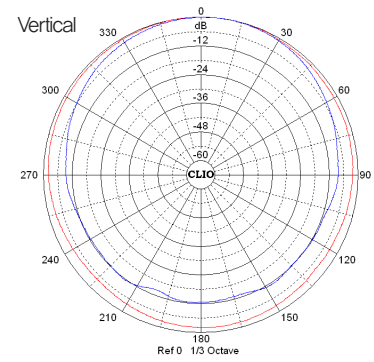
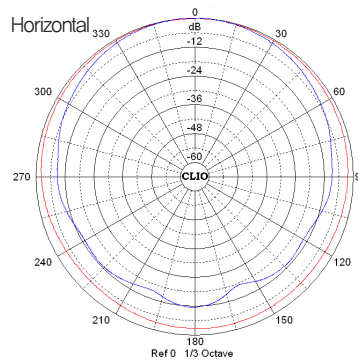

• WS-30T

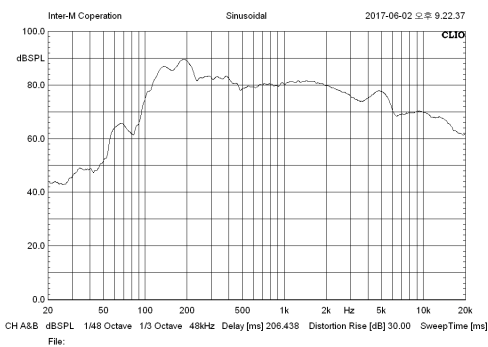

• WS-30T

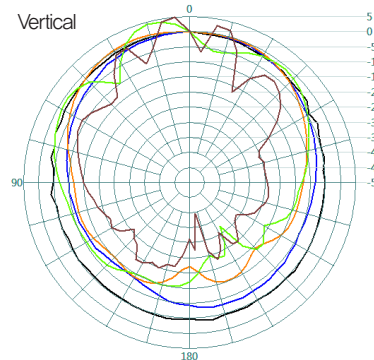
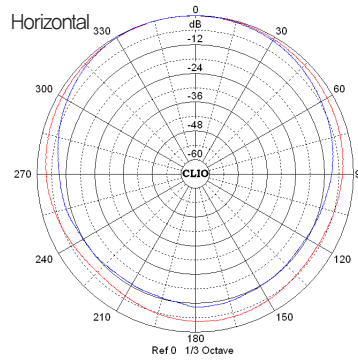

• WS-50T

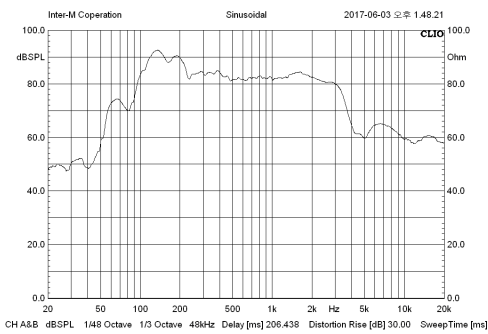

• WS-50T

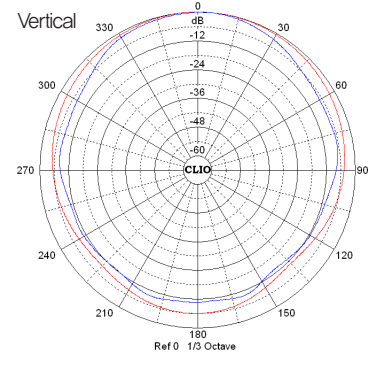
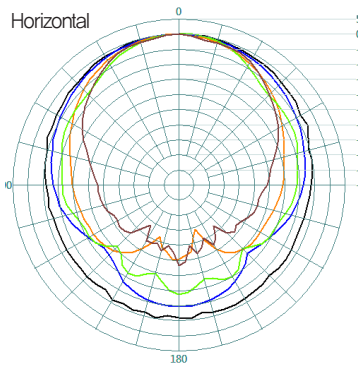

• WS-80T

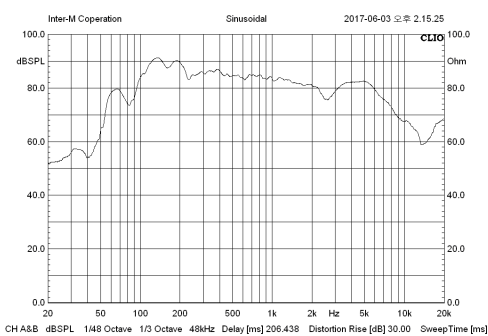

• WS-80T

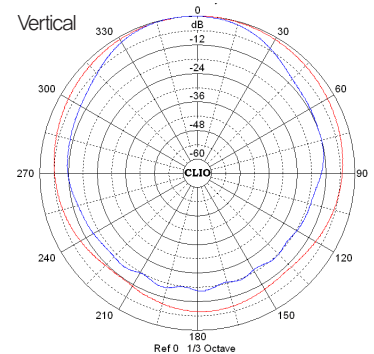
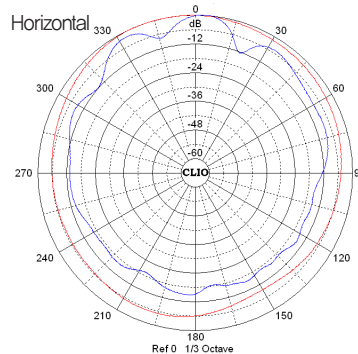

WS-15T/30T/50T/80T

Wall Speaker

SPEAKER INSTALLATION GUIDE

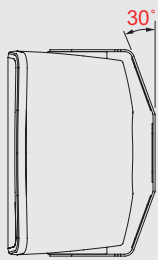

U Bracket

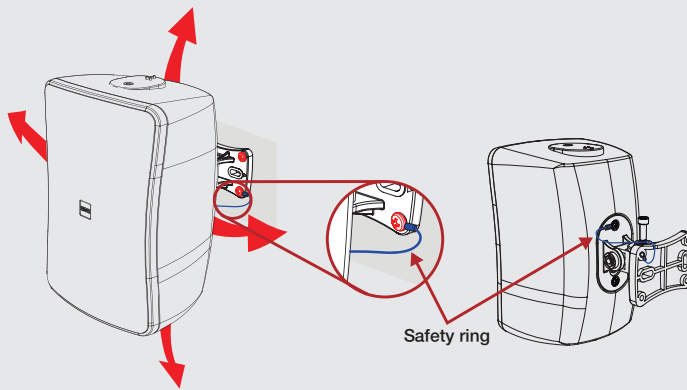

Knuckle Bracket

STEP 02

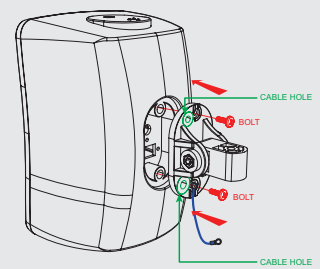

Back Cover

Wall Speaker

WS-203/210/230(I/B)

WS 200 series is providing a natural and smooth sound with a variety of it fits to any places that announcements and BGM required such as schools, government office, hotels and etc. And it ensures the quality and durability by acquiring KS certification in the Korea's first.



FEATURES

- High quality speaker driver
- Stylish and sleek design
- Easy installation
- Outdoor speaker
- High reliability
- WS-203/210 : 1Way Speaker system
(6.5" Full-range, adapt SUB-CONE)
- WS-230 : 2Way Speaker system
(6.5" Full-range, adapt SUB-CONE)

SPECIFICATION

Model		WS-203	WS-210	WS-230
Type		6.5" Full-range Wall Speaker (Sub Cone)	6.5" Full-range Wall Speaker (Sub Cone)	6.5" Full-range Wall Speaker (Sub Cone)
Driver		6.5"	6.5"	6.5" WF + 13mm TW
Power Handling (AES)		3W	10W	30W
Input Power	100V	3/2/1W	10/5/3W	30/20/10W
	70V	-	-	-
Impedance	100V	3.3kΩ / 5kΩ / 10kΩ	1kΩ / 2kΩ / 3.3kΩ	330Ω / 500Ω / 1kΩ
	70V	-	-	-
	LOW	-	-	-
Power Selection		-	-	-
Frequency Response(-10dB)		155Hz ~ 20kHz	145Hz ~ 20kHz	135Hz ~ 20kHz
Frequency Range(-20%)		123Hz ~ 20kHz	84Hz ~ 20kHz	99Hz ~ 20kHz
Sensitivity (1W/1m, 1kHz) ^{†1}		91dB	92dB	93dB
Maximum SPL[Cont] ^{†1}		96dB	102dB	108dB
Nominal Dispersion(HxV)	1kHz	142° x 191°	138° x 190°	148° x 190°
	4kHz	48° x 50°	46° x 46°	51° x 52°
Input Connector		Bi-Wired	Bi-Wired	Bi-Wired
Enclosure Material		HIPS (V0)	HIPS (V0)	HIPS (V0)
Enclosure Color		Black/Ivory	Black/Ivory	Black/Ivory
Grille Material		Jersey	Jersey	Jersey
Grille Color		Black/Ivory	Black/Ivory	Black/Ivory
Weights (Net)		1.1kg	1.2kg	2.2kg
Dimensions (Net, WxHxD, mm)		315 x 183 x 103	315 x 183 x 103	315 x 183 x 124
Weather Resistant		-	-	-
Flame Resistant		-	-	-
Certification		KS	KS	KS
Included Accessories		Anchor bolt x 1	Anchor bolt x 1	Anchor bolt x 1

^{†1} : At floor test

WS-203/210/230(I/B)

Wall
Speaker

TECHNICAL DATA

DIMENSION

• WS-203/210

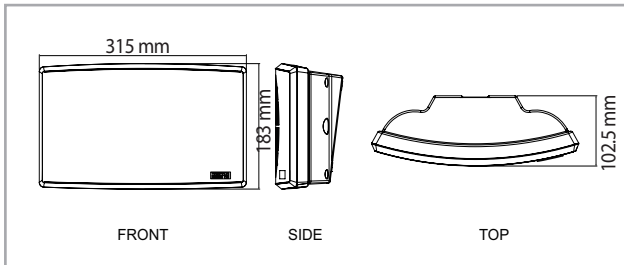

• WS-230

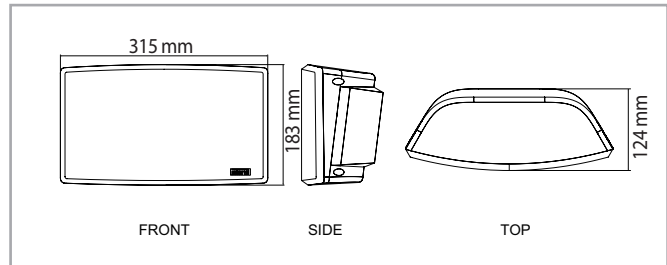

FREQUENCY RANGE

• WS-203

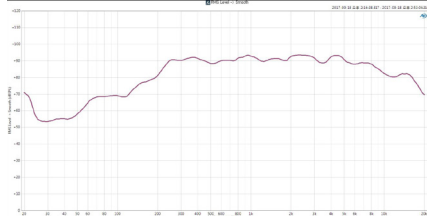

• WS-210

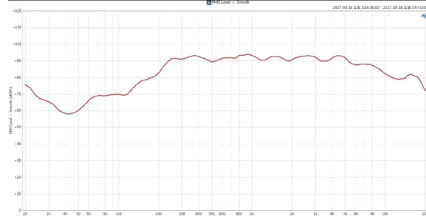

• WS-230

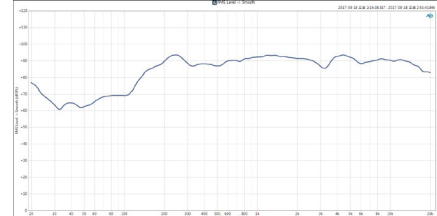

POLAR PATTERN

• WS-203

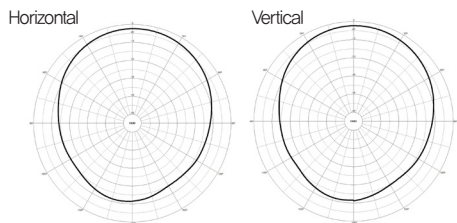

• WS-210

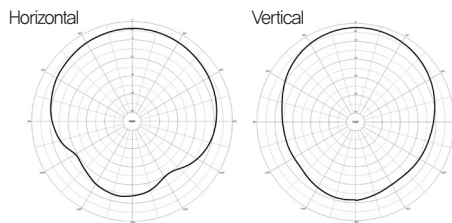

• WS-230

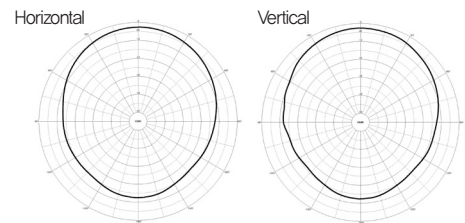

SPEAKER INSTALLATION GUIDE

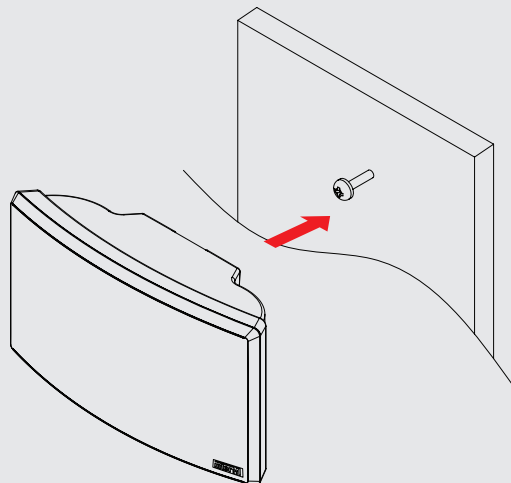

Wall Speaker

SWS-03/03A/10/10A(I/B)

SWS series is providing a natural and smooth sound with a variety of It fits to any places that announcements and BGM required such as schools, government office, hotels and etc. And it ensures the quality and durability by acquiring KS certification in the Korea's first.



FEATURES

- High quality speaker driver produce detail and rich sound
- Stylish and sleek design wall speaker
- Harmonized with general structure when installed
- Sound volume adjustable with attenuator
(SWS-03A/10A)

SPECIFICATION

Model		SWS-03	SWS-03A	SWS-10	SWS-10A
Type		6.5" Full-range Wall Speaker	6.5" Full-range Wall Speaker	6.5" Full-range Wall Speaker	6.5" Full-range Wall Speaker
Driver		6.5"	6.5"	6.5"	6.5"
Power Handling (AES)		3W	3W	10W	10W
Input Power	100V	3/2/1W	3/2/1W	10/5/3W	10/5/3W
	70V	-	-	-	-
Impedance	100V	3.3kΩ / 5kΩ / 10kΩ	3.3k/5k/10kΩ	1kΩ / 2kΩ / 3.3kΩ	1k/2k/3.3kΩ
	70V	-	-	-	-
	LOW	-	-	-	-
Power Selection		-	Rotary Switch	-	Rotary Switch
Frequency Response(-10dB)		143Hz ~ 14.7kHz	143Hz ~ 14.7kHz	145Hz ~ 12.6kHz	145Hz ~ 12.6kHz
Frequency Range(-20%)		114Hz ~ 20kHz	114Hz ~ 20kHz	117Hz ~ 17.4kHz	117Hz ~ 17.4kHz
Sensitivity (1W/1m, 1kHz) ^{†1}		89dB	89dB	90dB	90dB
Maximum SPL[Cont] ^{†1}		94dB	94dB	100dB	100dB
Nominal Dispersion(HxV)	1kHz	171° x 131°	171° x 131°	178° x 129°	178° x 129°
	4kHz	50° x 49°	50° x 49°	49° x 49°	49° x 49°
Input Connector		4P Screw Terminal	4P Screw Terminal	4P Screw Terminal	4P Screw Terminal
Enclosure Material		HIPS	HIPS	HIPS	HIPS
Enclosure Color		Black/Ivory	Black/Ivory	Black/Ivory	Black/Ivory
Grille Material		Jersey	Jersey	Jersey	Jersey
Grille Color		Black/Ivory	Black/Ivory	Black/Ivory	Black/Ivory
Weights (Net)		1.10kg	1.10kg	1.34kg	1.34kg
Dimensions (Net, WxHxD, mm)		182 x 274 x 120	182 x 274 x 120	182 x 274 x 120	182 x 274 x 120
Weather Resistant		-	-	-	-
Flame Resistant		-	-	-	-
Certification		-	-	-	-
Included Accessories		Anchor bolt x 1	Anchor bolt x 1	Anchor bolt x 1	Anchor bolt x 1

^{†1} : At floor test

SWS-03/03A/10/10A(I/B)

Wall
Speaker

TECHNICAL DATA

DIMENSION

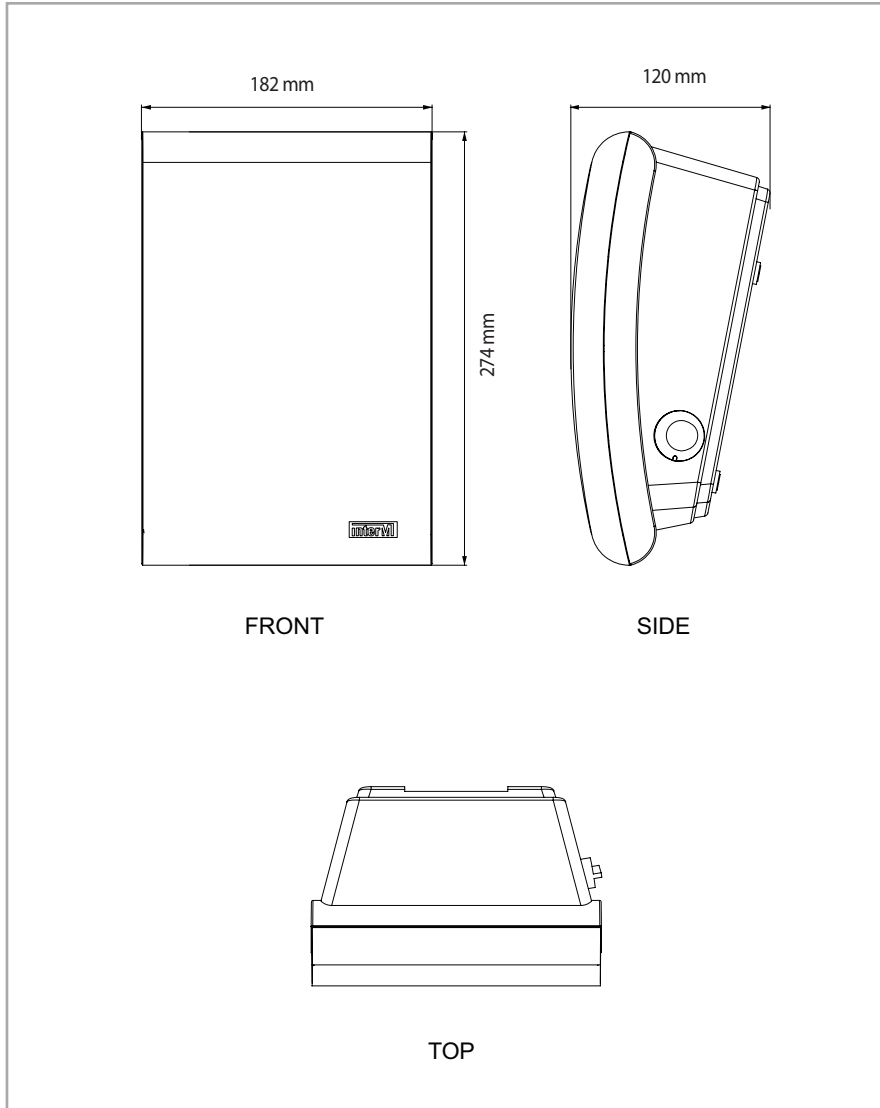

Wall Speaker

SWS-03/03A/10/10A(I/B)

TECHNICAL DATA

FREQUENCY RANGE

• SWS-03

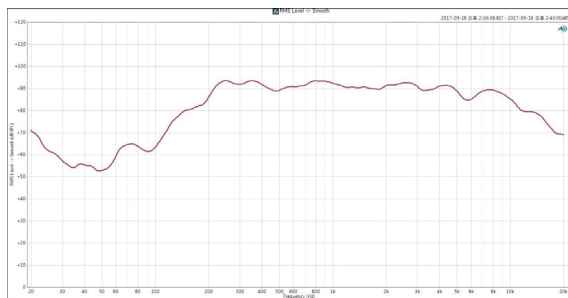

• SWS-03A

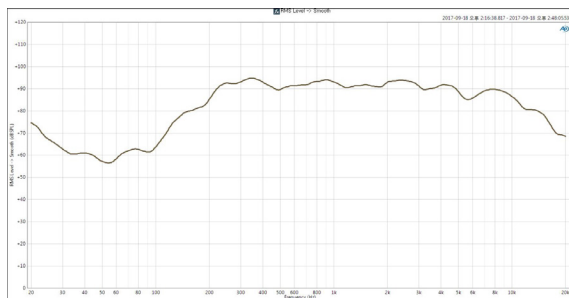

POLAR PATTERN (1 kHz)

• SWS-03/03A

Horizontal

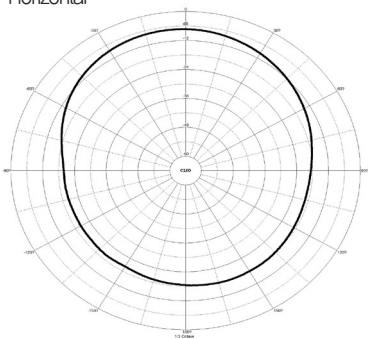

Vertical

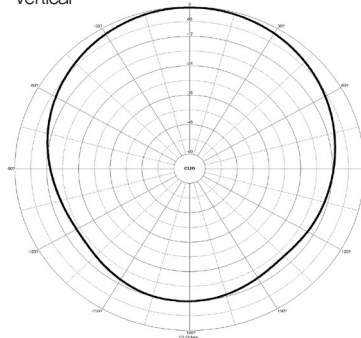

FREQUENCY RANGE

• SWS-10

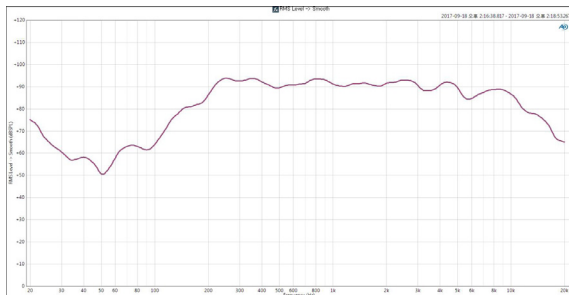

• SWS-10A

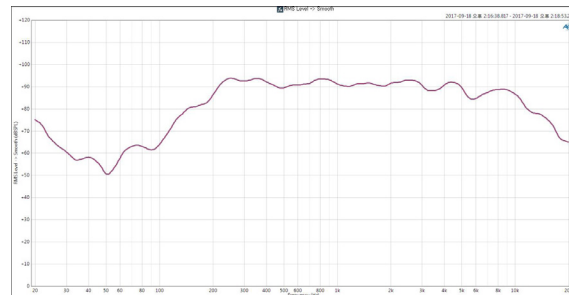

POLAR PATTERN (1 kHz)

• SWS-10/10A

Horizontal

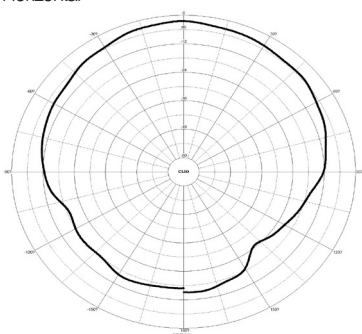

Vertical

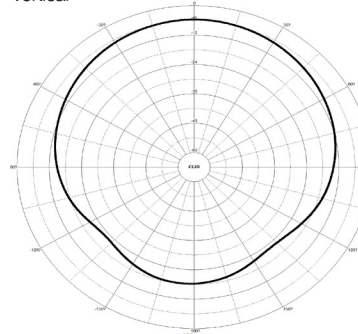

SWS-03/03A/10/10A(I/B)

Wall
Speaker

SPEAKER INSTALLATION GUIDE

• SWS-03A/10A

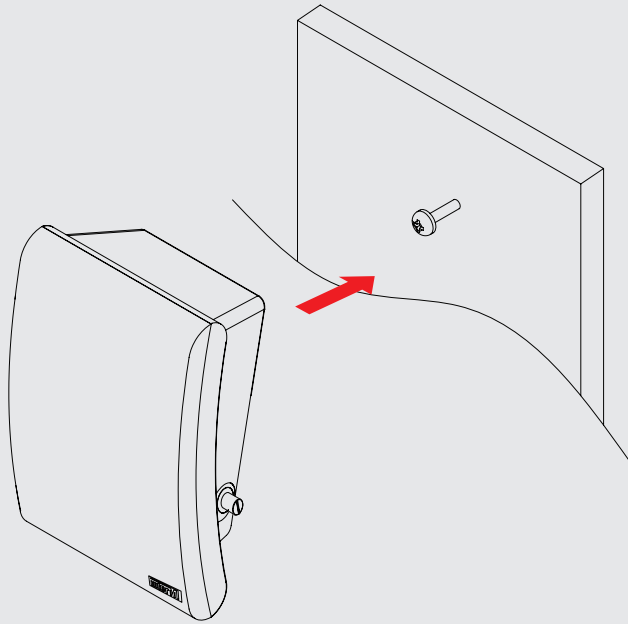

• SWS-03/10

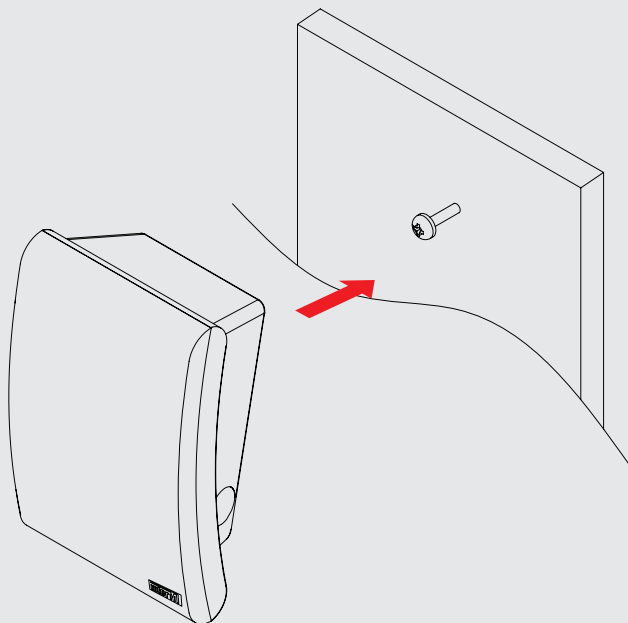

Wall Speaker

IWS-10/10A(I/B)

IWS series is providing a natural and smooth sound with a variety of It fits to any places that announcements and BGM required such as schools, government office, hotels and etc. And it ensures the quality and durability by acquiring KS certification in the Korea's first.



FEATURES

- High quality speaker driver
- Stylish and sleek design wall speaker
- A design adopted in modern sense
- Sound volume adjustable with attenuator (IWS-03A/10A)

SPECIFICATION

Model	IWS-10		IWS-10A	
Type	6.5" Full-range Wall Speaker		6.5" Full-range Wall Speaker	
Driver	6.5"		6.5"	
Power Handling (AES)	10W		10W	
Input Power	100V	10W / 3W	10/3W	
	70V	-	-	
Impedance	100V	1kΩ / 3.3kΩ	1k/3.3kΩ	
	70V	-	-	
	LOW	-	-	
Power Selection	-		Rotary Switch	
Frequency Response(-10dB)	150Hz ~ 15kHz		150Hz ~ 15kHz	
Frequency Range(-20%)	120Hz ~ 17.9kHz		120Hz ~ 17.9kHz	
Sensitivity (1W/1m, 1kHz) ^{*1}	90dB		90dB	
Maximum SPL[Cont] ^{*1}	100dB		100dB	
Nominal Dispersion(HxV)	1kHz	180° x 171°	180° x 171°	
	4kHz	75° x 100°	75° x 100°	
Input Connector	3P Screw Terminal		3P Screw Terminal	
Enclosure Material	HIPS		HIPS	
Enclosure Color	Black/Ivory		Black/Ivory	
Grille Material	Jersey		Jersey	
Grille Color	Black/Ivory		Black/Ivory	
Weights (Net)	1.1kg		1.1kg	
Dimensions (Net, WxHxD, mm)	179 x 312 x 109		179 x 312 x 109	
Weather Resistant	-		-	
Flame Resistant	-		-	
Certification	-		-	
Included Accessories	Anchor bolt x 1		Anchor bolt x 1	

*1 : At floor test

IWS-10/10A(I/B)

Wall
Speaker

TECHNICAL DATA

DIMENSION

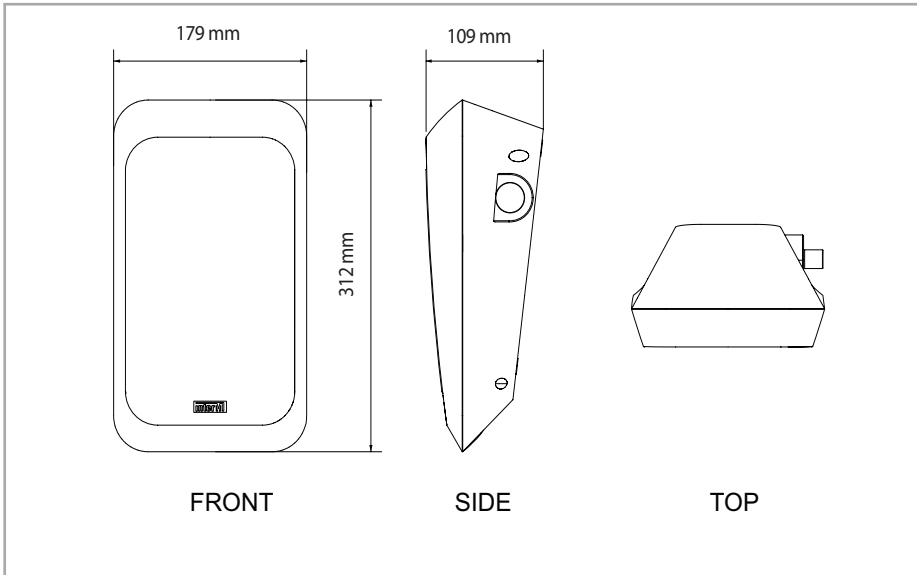

FREQUENCY RANGE

• IWS-10

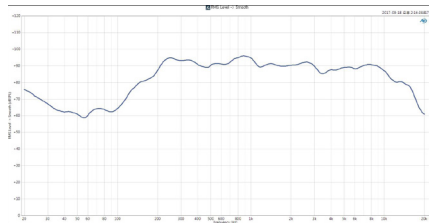

• IWS-10A

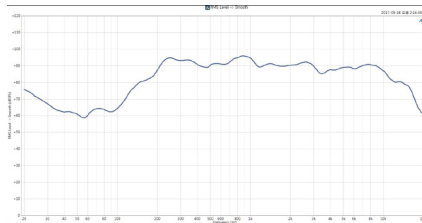

SPEAKER INSTALLATION GUIDE

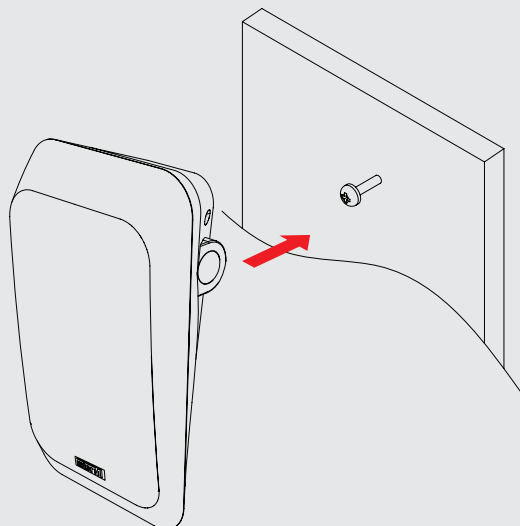

Wall Speaker

CI-20T/30T

The CI series elegant and stylish speaker design is manufactured from a precision-machined and acoustic tuned. It is full-range with a uniform frequency response pristine sound quality. The CI Series speakers are ideal for BGM playback and also offer precise voice reproduction. Articulated mounting bracket offers ease of installation with precision speaker orientation.



FEATURES

- Compact vented enclosure
- Coaxial dual-cone driver
- High-output drivers
- Moisture & Dust proof
- Optimized sound quality on music playback & voice intelligibility
- Circuit protection
- High quality transformer
- Articulated mounting bracket
- Rotatable logo plate

SPECIFICATION

Model		CI-20T	CI-30T
Type		4" Full-range Wall Mount Speaker	4" Full-range Wall Mount Speaker
Driver		4"	4"
Power Handling (AES)		20W	30W
Input Power	100V	20W	30W
	70V	-	-
Impedance	100V	500Ω	333Ω
	70V	-	-
	LOW	8Ω	8Ω
Power Selection		By Terminal	By Terminal
Frequency Response(-10dB)		94Hz ~ 16kHz	96Hz ~ 20kHz
Frequency Range(-20%)		67Hz ~ 19kHz	70Hz ~ 20kHz
Sensitivity (1W/1m, 1kHz)		83dB	83dB
Maximum SPL[Cont]		96dB	98dB
Nominal Dispersion(HxV)	1kHz	204° x 206°	205° x 203°
	4kHz	100° x 115°	100° x 110°
Input Connector		3P Screw Terminal	3P Screw Terminal
Enclosure Material		V0	V0
Enclosure Color		Black/White	Black/White
Grille Material		Metal Grille	Metal Grille
Grille Color		Black/White	Black/White
Weights (Net)		1.54kg	1.58kg
Dimensions (Net, WxHxD, mm)		143 x 230 x 151	143 x 230 x 151
Weather Resistant		IP34	IP34
Flame Resistant		○	○
Certification		KS	KS
Included Accessories		Knuckle Bracket, Safety Wire	Knuckle Bracket, Safety Wire

CI-20T/30T

Wall Speaker

TECHNICAL DATA

DIMENSION

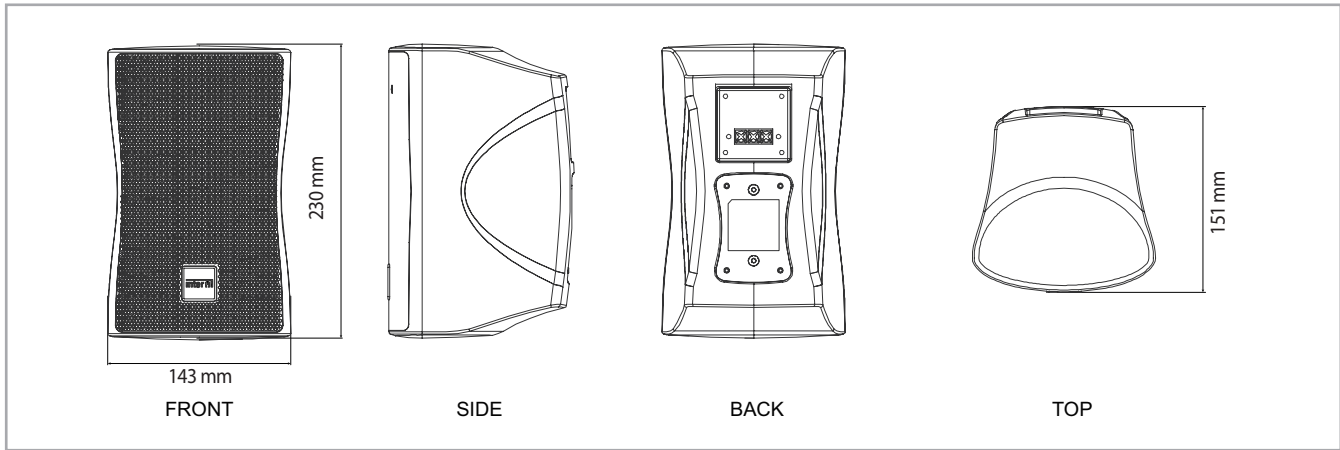

FREQUENCY RANGE

• CI-20T

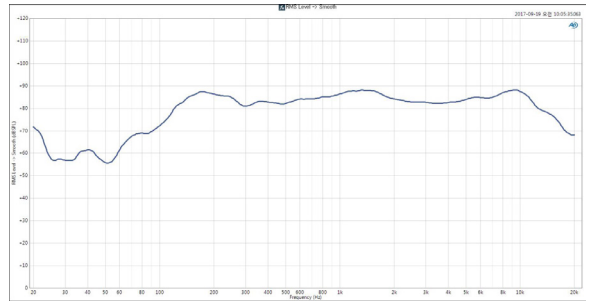

POLAR PATTERN (1kHz)

Horizontal

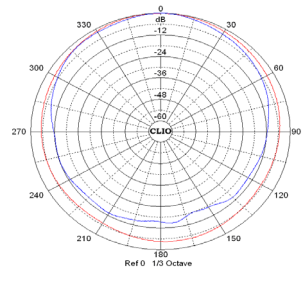

Vertical

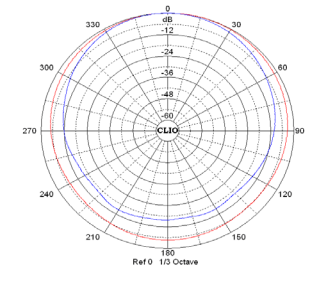

• CI-30T

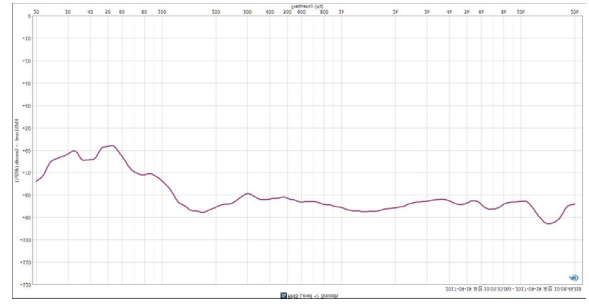

Horizontal

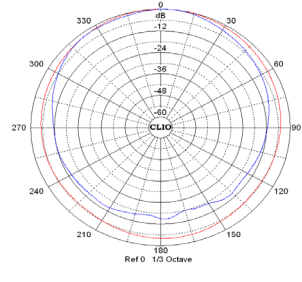

Vertical

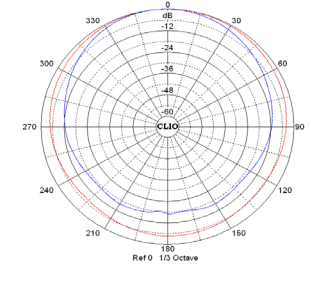

Wall Speaker

GS-20

GS-20(B/W) is optimized High quality wall speaker for monitoring the broadcasting.

It is tuned to play the entire frequency range for BGM playback and precise voice reproduction, and designed by the 2Way circuit applicable to various environments.



FEATURES

- 4" 2Way speaker system
- High quality matching transformer
- Contains a premium grade speaker driver
- Best reliability
- The beautiful and graceful cabinet design
- Easy installing and convenience

● Input terminal

GS-20

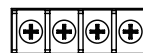

SPECIFICATION

Model	GS-20	
Type	5" 2way Wall Mount Speaker	
Driver	5" WF, 0.45" TW	
Power Handling (AES)	20W	
Input Power	100V	20W
	70V	-
Impedance	100V	500Ω
	70V	-
	LOW	16Ω
Power Selection	By Terminal	
Frequency Response(-10dB)	82Hz ~ 20kHz	
Frequency Range(-20%)	59Hz ~ 20kHz	
Sensitivity (1W/1m, 1kHz)	82dB	
Maximum SPL[Cont]	95dB	
Nominal Dispersion(HxV)	1kHz	221° x 195°
	4kHz	62° x 75°
Input Connector	4P Screw Terminal	
Enclosure Material	ABS UL 94 HB	
Enclosure Color	Black/White	
Grille Material	ABS UL 94 HB	
Grille Color	Black/White	
Weights (Net)	1.8kg	
Dimensions (Net, WxHxD, mm)	160 x 250 x 170	
Weather Resistant	-	
Flame Resistant	-	
Certification	-	
Included Accessories	Knuckle Bracket, Safety Wire	

TECHNICAL DATA

DIMENSION

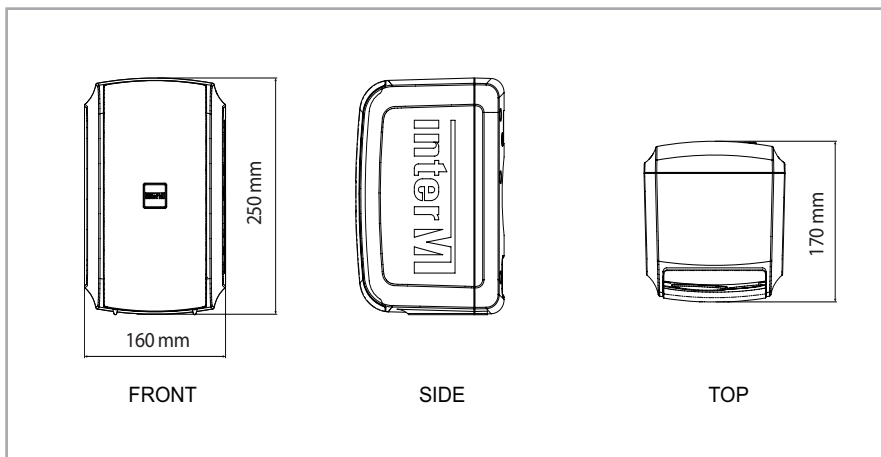

FREQUENCY RANGE

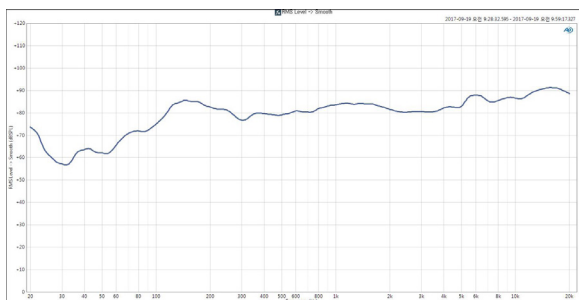

POLAR PATTERN (1kHz)

Horizontal

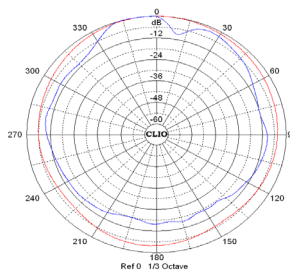

Vertical

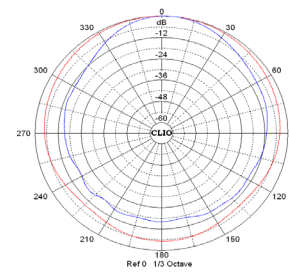

SPEAKER INSTALLATION GUIDE

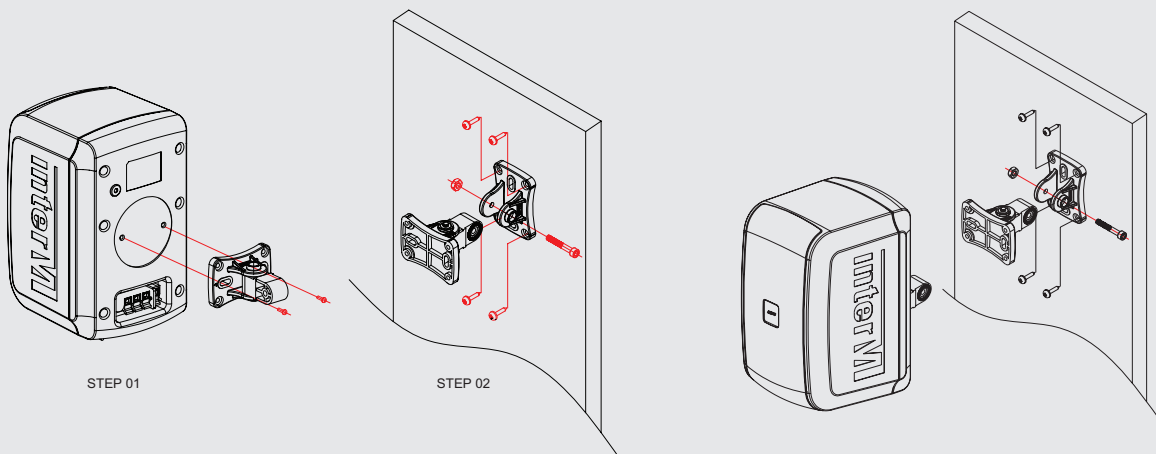



Inter-M Corp. (IMK)

719, Dobong-ro, Dobong-gu, Seoul, Korea
Overseas Sales Team

Tel_ +82-2-2289-8141~7 Fax_ +82-2-2289-8149 E-mail_ overseas@inter-m.com

www.inter-m.com

※ Design and specification are subject to be changed for the improvement of product quality without pre notice.

2019. 1. V7